



AGS-Medical
Ph: (505) 550-6501 & (505) 565-5102
Fx: (505) 814-5778
Em: sales@agsmedical.com
Web: <http://www.agsmedical.com>

**Trusted
Healthcare
&
PPE
Supplier for you!**

[01]

.....

MEDCROSS™ & SUPERSOFT™

SURGICAL GOWNS MEETS EN13795



[06]

.....

GREENCARE™

AAMI PB70 ISOLATION GOWN



[15]

.....

CROSSGARD™

PROTECTIVE COVERALLS



[17]

.....

GREENCARE™

SURGICAL DRAPES

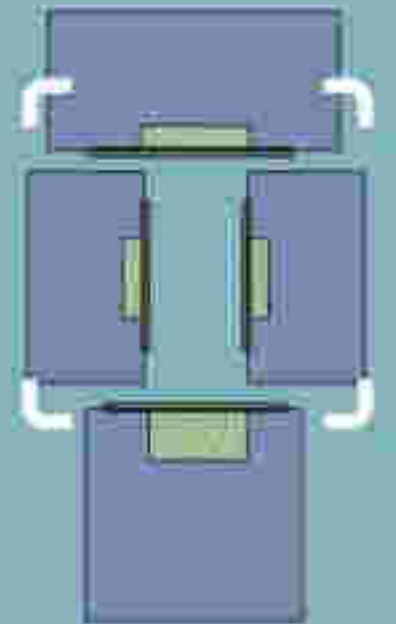

[21]

.....

ACCESSORIES

CAPS, HOODS



[23]

.....

CROSSGARD™

BOOT COVERS, SHOE COVERS



[25]

.....

GREENCROSS™

PROFESSIONAL MASKS & RESPIRATORS



A smiling woman in a blue surgical cap and gown is the central focus of the image. She is in an operating room, with other medical staff in similar attire visible in the background. The lighting is bright and clinical.

AAMI PB70

Why are more hospitals and purchasing groups choosing GREEN CROSS for their all-around protection?

Our medical products provide the highest protection with the greatest comfort at the lowest cost.

Our medical apparel line includes generously sized footwear, protective headwear, gowns that meet AAMI PB70 requirements, protective multi-purpose gowns, a full range of protective coveralls and comfortable, colorful lab coats and lab jackets.

We know you rely on disposable apparel to keep your staff protected and comfortable. For this reason, we use the finest materials available for protection, offering the greatest level of comfort. We apply the highest quality standards to our products and in our manufacturing facilities.



GREEN CROSS is TUV ISO 13485-2003 certified and FDA Registered.
GREEN CROSS has been manufacturing protective apparel for over 15 years.

SURGICAL GOWN BARRIER CLASSIFICATIONS

US MARKET AAMI PB70:2003 & EU MARKET EN13795



WHAT IS EN 13795 ?

EN 13795 is a norm that has been approved by CEN on September 6, 2004 and is acknowledged as the European standard that controls and confirms the crucial requirements of all medical devices such as surgical gowns, drapes and clean air suits, both disposable and non disposable textiles.

Parts of EN13795

1. Basic information for the manufacturers, converters and for the processors such as traceability processes and validation of all steps.

2. Testing methods that evaluate specifications explained on Part1.

For instance;
EN ISO 22610; resistance to wet microbial penetration
EN ISO 22612; resistance to dry microbial penetration etc.

3. Defining the minimum and maximum standards depending on the conditions of the surgical operations.



EN 13795-2:2004	
EN ISO 22610:2006	Resistance to wet microbial penetration
EN ISO 22612:2005	Protection against infection agents
EN ISO 9073-10:2003	Assessment of linting and particulate matter
EN 1174-2:1996	Microbial cleanliness
EN 13938-1:1999-wet	Determination of bursting strength
EN 29073-3:1992-wet	Determination of the breaking strength and elongation

1. Adjustable neckline on GREENGARD™

gowns, colour-coated available for plus information.

2. Raglan or Set-in sleeves provides

different options for greater freedom of movement

3. Extra Long Cotton Knitted Cuffs

Latex-free, keeps the gloves tight and safe on surgeon's hand.

4. Ultrasonic welding on critical parts for excellent protection.

The technology of ultrasonic welding makes the jointing part seamless and faultless, which forms ultimate barrier to fluid and bacteria. Comparing with traditional sewing stitches, it makes the gown more protective and stronger.

5. The 5th Generation SMMMS fabric

Our SMS technology utilizes five layers of fabric to provide a high level of fluid repellency. This helps provide a barrier to blood, body fluids and pathogens, the fabric features three densely-packed meltblown layers sandwiched between two strong spunbond outer layers. Strategy raw material supplier PGI, Ahlstrom, SAAF.



6. Low-linting

All gowns are very low linting, minimizing the risk of introducing particles into the O.R.

7. Latex-Free

All gowns are latex free. All of our packaging is clearly labeled with latex-free symbol for added piece of mind.





MEDCROSS™

High Performance Surgical Gown

GSG80

5-layer anti-static breathable SMMMS fabric with AR+AS Treatment

- High level anti-static treatment
- Excellent microbial barrier
- Excellent physical barrier to contaminants and fluids
- Stronger fabric with a matte finish, resistance to tears
- Softer fabric with comfort inside and outside
- Book fold is available
- Ultrasonic sealed seam or Three thread over-lock Serged seam



Raglan Sleeve



Ser-in Sleeve

MEDCROSS™

High Performance Surgical Gown

Critical Zone Reinforced

- PE or Fabric internal strengthening to grant the maximum protection against possible blood and blood products contaminations.



◆ PP+PE, SMS, Impregnated paper

All 3 kinds of reinforcement pads can be applicable for reinforced surgical gowns

This high performance nonwoven fabric is made by Reifenhauser IV line.

The new SMMMS fabric is available with antistatic and alcohol-repellent finishes. It delivers high fluid and particulate barrier and is soft, strong and low in lint. Compatible with ethylene oxide, steam, and gas plasma sterilization, it is available for AAMI PB70 Level 3 and EN 13795 High Performance.



Alcohol Repellent



Anti-Blood

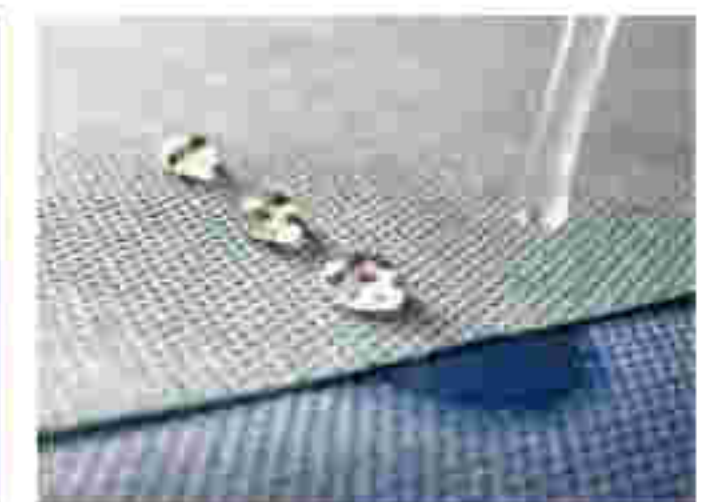

Oil Repellent

APPLICATION



1PC/BAG, 30PCS/CTN



Cat. I^a

MEDCROSS™

Multiply Surgical Gown

GSG10

5-layer anti-static breathable SMMMS fabric

- Excellent microbial barrier
- Excellent physical barrier to contaminants and fluids
- Stronger fabric with a matte finish, resistance to tears
- Softer fabric with comfort inside and outside
- Book folded.
- Sterile by ETO



Ultrasonic sealed seam

MEDCROSS™

Multiply Surgical Gown

Critical Zone Reinforced

- PE or Fabric internal strengthening to grant the maximum protection against possible blood and blood products contaminations.

Folding Steps:



A



B



C



D



E



F

APPLICATION



1PC/BAG,30PCS/CTN



Cat. I^a





SUPERSOFT™

Spunlace Basic Surgical Gown

GSG31

It is made of polyester reinforced cellulose nonwoven (Spunlace) with anti-static and fluid resistance. The extreme softness provide surgical gowns cloth-like feel and a good level of comfort for those who spend much of their day in a surgical gown. It keeps wearers cool and comfortable.

For light to moderate blood exposure, protecting surgeon, first assistance and scrub nurses. Earns AAMI Level 3 Protection and EN13795 with Reinforcement.

Features:

- Soft spunlace fabric (made of woodpulp and polyester)
- Fluid repellent
- Generous cut
- Velcro neck binding
- Book fold
- Sterile by ETO
- Ultrasonic sealed seam
- Critical zone reinforced optional

SUPERSOFT™

Spunlace Reinforced Surgical Gown

GSG51

PE or Fabric internal strengthening to grant the maximum protection against possible blood and blood products contaminations.

SUPERSOFT™ & MEDCROSS™

XL-XL



EN 13795 HP | AAMI 3

Made in China

L

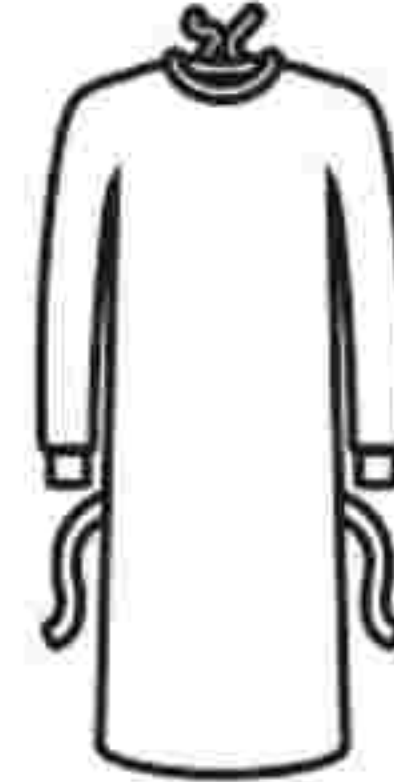

EN 13795 SP | AAMI 2

Made in China

APPLICATION



1PC/BAG,30PCS/CTN



Cat. I^a

SURGICAL GOWN BARRIER CLASSIFICATIONS

US MARKET AAMI PB70:2003 & EU MARKET EN13795



MEDCROSS™ High Performance Surgical Gown

MEDCROSS™ High Performance Reinforced Surgical Gown



MEDCROSS™ Multiply Surgical Gown

MEDCROSS™ Multiply Reinforced Surgical Gown



SUPERSOFT™ Spunlace Basic Surgical Gown

SUPERSOFT™ Spunlace Reinforced Surgical Gown

GREENCARE™

SMS Isolation Gown

GSG50

Level 1 and Level 2

Gowns made from multiply medium weight and lightweight SMS material. The GreenCare™ Isolation Gowns meet the test requirements set forth by the Association for the Advancement of Medical Instrumentation (AAMI) PB70. Provide barrier protection based on AAMI guidelines and helps reduce the risk of contamination and transmission of infectious organisms which lead to HAIs.

Three-Layer SMS Fabric:

Outer layers-Cloth-like, yet tough and abrasion-resistant

Middle layer-Intricate web of microfibers that filters out many water-based liquids

For more than a decade, Green Cross has used this technology to manufacture the leading gowns in the healthcare market.

Easy to wear

The tape tab neck closure makes these gowns easy to put on and take off.



Meets AAMI Levels 1 & 2

The gowns meet the Association for the Advancement of Medical Instrumentation (AAMI) PB70 standard, "Liquid barrier performance and classification of protective apparel and drapes intended for use in health care facilities."

Medium Weight Gown – Level 2

(protection against low levels of fluids)

Lightweight Gown – Level 1

(protection against minimal levels of fluids)

Low-linting

Because these gowns are made from polypropylene, they are low in lint.



LEVEL 2



LEVEL 1

APPLICATION



10PC/BAG, 50PCS/CTN



Cat. I^a

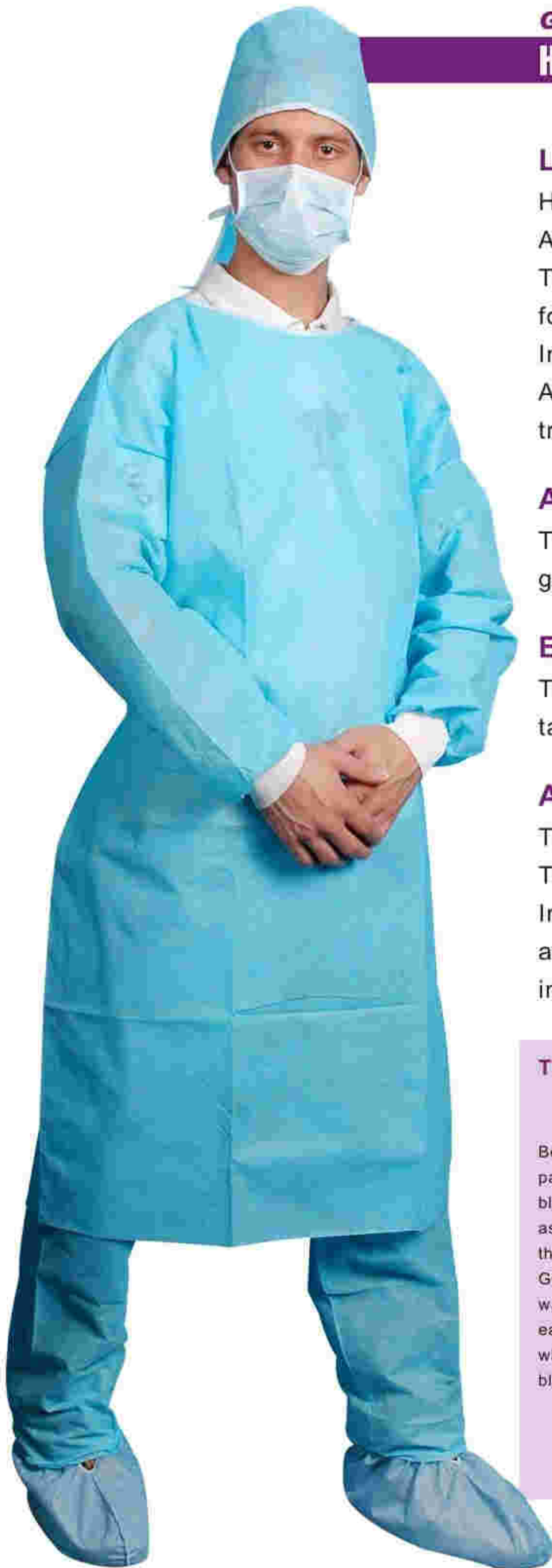

GREENCARE™

High Performance Isolation Gown

Level 3/EN13795

High Performance fabric is based on Ahlstrom's Nonwovens Advanced Composite technology.

The GreenCare™ Isolation Gowns meet the test requirements set forth by the Association for the Advancement of Medical Instrumentation (AAMI) PB70. Provide barrier protection based on AAMI guidelines and helps reduce the risk of contamination and transmission of infectious organisms which lead to HAIs.

Adjustable neckline

The hook-and-loop neck closure allows for easy adjustments and a good fit

Easy to wear

The tape tab neck closure makes these gowns easy to put on and take off.

AAMI Level 3 protection

These gowns provide protection against moderate levels of fluids. The gowns meet the Association for the Advancement of Medical Instrumentation (AAMI) PB70 standard, "Liquid barrier performance and classification of protective apparel and drapes intended for use in health care facilities" – Level 3.

The Breathable Layer Blocks Out Blood, Bacteria, and Microorganisms

Because moisture vapor particles are much smaller than blood droplets and other fluids, as well as viruses and bacteria, the GreenCare™ Surgical Gown's inner film layer allows water vapor to pass through easily, keeping the wearer cool while providing protection from blood and body fluids.

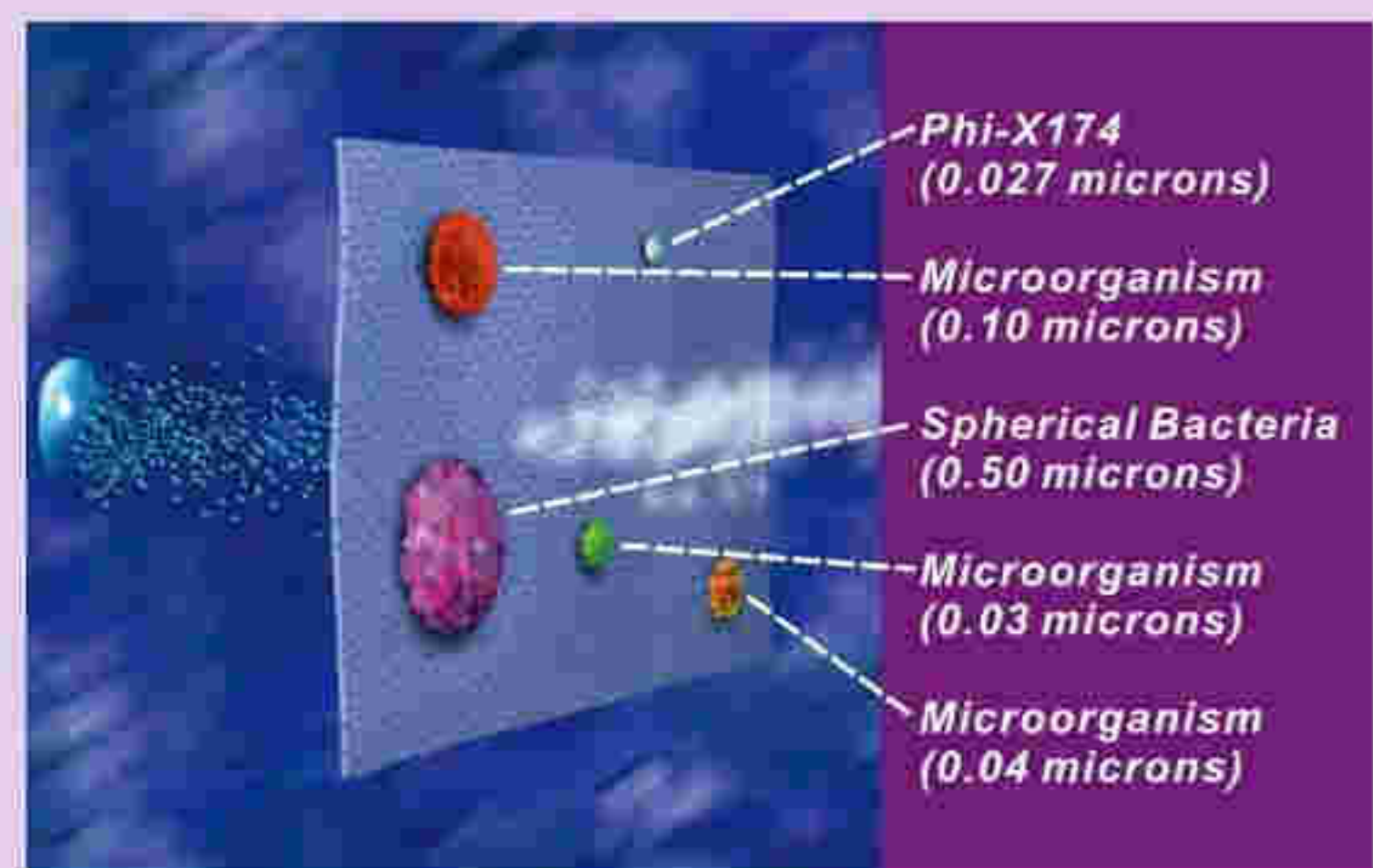

Illustrated particles are not representative of actual size.

Breathable High Performance Protection and Comfort Levels



LEVEL 3

APPLICATION



10PC/BAG, 50PCS/CTN



Cat. I^a



GREENGARD™
SMS Impervious Gown

Thumbs Up Fluid-Proof Breathable Gown is styled to prevent sleeves from sliding. Our least expensive impervious, breathable gown is offered in the highly successful Thumbs Up style with the convenient thumb loop preventing sleeves from sliding up when putting on gloves. Reinforced polypropylene-film offers breathability in addition to strength for extended wear periods.

Multi-ply material: The SMS material provides AAMI level 2 barrier.



Features:

1. Over-the-head neck style, open back, Heat seam provides high protection
2. Thumb loop wrists feature elastic for a good gown and glove fit
3. Apron-style neck enables gown to be placed on and off quickly
4. Individually folded and wrapped gowns in dispenser box

Package:

Specially folded and packaged in individual pouches. Includes dispenser box.



LEVEL 2

GREENGARD™
Coated Impervious Gown

These gowns are made by PE coated PPSB fabric to help prevent strikethrough by fluids. The fabric is proved passing ASTM F1670 / 1671 for protection on blood / virus. Different AMMI level could be requested with different seams.

Poly-Coated PP: Provide excellent fluid-resistant protection.

Features:

1. Over-the-head neck style, open back, Heat seam provides high protection
2. Thumb loop wrists feature elastic for a good gown and glove fit
3. Apron-style neck enables gown to be placed on and off quickly
4. Individually folded and wrapped gowns in dispenser box

Package:

Specially folded and packaged in individual pouches. Includes dispenser box.



LEVEL 4



APPLICATION



15PC/BOX, 75PCS/CTN



Cat. I^a



Spunbonded Polypropylene Isolation Gown

These protective garments are available in single-layer spunbonded polypropylene for basic coverage or a tri-layer SMS fabric for increased fluid resistance. Each gown features a waist belt and latex-free elastic or knitted cuffs. Choose from either ties or a tape tab at the neck.

Besides, there are Open-back or Full-back optional styles.

1. Basic Polypropylene Isolation Gown
2. Made from lightweight, fluid-repelling polypropylene material
3. Generously sized for full coverage and flexibility
4. Styles available in classic neck and waist ties with elastic wrists or over-the-head with thumb loop wrists
5. Low in Lint

APPLICATION



10PC/BAG, 100PCS/CTN



Cat. I^a

Note: These gowns are constructed of a fabric that offers high fluid protection, yet due to seam construction, the gowns do not meet the AAMI PB70 Standard. For gowns that meet AAMI standards, please refer to front pages.

Standard Polyethylene-Coated Polypropylene Gown

Coated material Made from polypropylene and polyethylene coated together. Choose from two weights: medium weight and heavyweight.

Two options for wrists

The gowns feature comfortable latex-free knit or elastic wrists with neck and waist ties.

Protection from fluids

The gowns provide great fluid protection.

Low-linting

Polypropylene fabric makes these gowns low in lint.

APPLICATION



10PC/BAG, 100PCS/CTN



Cat. I^a





Classic Lab Jacket with Knit Collar and Knit Cuffs

The Classi Lab Coat is made from a fluid resistant multi-layer material to provide comfort and protection for everyday needs. Green Cross's disposable products are available with a five snap closure, reinforced pockets and a convenient loop inside for hanging. Enjoy our variety to fit your facility's needs.

Specifications

- | | |
|--------------------------------|----------------------------------|
| 1. Spun bonded polypropylene | 4. Plastic snaps |
| 2. Sewn pockets and seams | 5. Class One flammability rating |
| 3. Cotton knit cuff and collar | 6. Latex-free |

APPLICATION



10PC/BAG,50PCS/CTN



Cat. I^a



SuperSoft™ Scrub Suit



with Round Neck

The SuperSoft™ Scrub Suit offers non-transparent complete coverage made from breathable, fluid-resistant, multi-layer silk-like super soft SMS with anti-static treatment which helps protect them from fluid and bacteria. There are V-shape and Round-shape neck available, open short sleeve and pockets, which offer the wearer experience of regular clothes

APPLICATION



10PC/BAG,50PCS/CTN



Cat. I^a

SuperSoft™ Scrub Suit

with V-Shape Neck





Classic Polypropylene Lab Coat

The Standard Polypropylene Lab Coat is made from a fluid resistant multi-layer material to provide comfort and protection for everyday needs. Green Cross's disposable products are available with a five snap closure or zip or Velcro front, reinforced sleeve, back vent for extended wear and a convenient loop inside for hanging. Enjoy our variety to fit your facility's needs.

1. Knit cuffs.
2. Traditional collar.
3. Six-snap front closures.
4. Three reinforced pockets.
5. Back vent.
6. Neck loop for hanging.
7. White.



10PC/BAG, 50PCS/CTN



Cat. I^a

APPLICATION



Classic SMS Lab Coat

SMS is made of meltblown polypropylene sandwiched between two layers of spunbonded polypropylene. More fluid resistant than common spunbonded material, the multi-layered SMS apparel offers better protection for any level of exposure in a variety of health care situations.

Exposure Anticipated: Potential for moderate fluid contact and extended use. Sized generously and softer than regular spunbonded materials, latex-free SMS apparel drapes easily.

1. Knit cuffs.
2. Traditional collar.
3. Six-snap front closures.
4. Three reinforced pockets.
5. Back vent.
6. Neck loop for hanging.
7. White.



10PC/BAG, 50PCS/CTN



Cat. I^a

APPLICATION



SUPERSOFT™ Traditional Patient Gown

Traditional Patient Gown are made with soft SMS materials. Offers non-transparent complete coverage. There are non-sleeve type, short-sleeve type and long-sleeve type, always can satisfy your requirement to patient gowns. With ties at the neck and waist, which protects the wearer better. It is suitable for both staff and patient.

Features

1. Generously cut
2. Can be worn as a rear or front closure gown
3. Ideal for extended wear and multi-phase procedures
4. Waist ties are attached



10PC/BAG, 50PCS/CTN



Cat. I^a



SUPERSOFT™ Patient Wrap Gown

Wrap Patient Gown are made with soft SMS materials. Offers non-transparent complete coverage. There are Kimono type, Robe type and 3-Armhole type, always can satisfy your requirement to patient gowns. With ties attached, which protects the wearer better.

Features

1. Generously cut
2. Ideal for extended wear and multi-phase procedures
3. Waist ties are attached



10PC/BAG, 50PCS/CTN

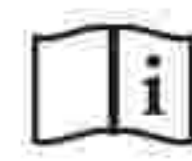

Cat. I^a



Scrim Reinforced Tissue Gown

Scrim Reinforced Tissue Gown is made of 4ply or 3ply SCRIM Reinforced Tissue material provides fabric-like Excellent durability, modesty and comfort.

Features

1. Generously cut
2. Ideal for extended wear and multi-phase procedures
3. Provides comfort with modest coverage



10PC/BAG, 100PCS/CTN

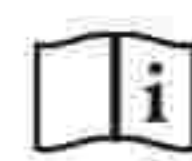

Cat. I^a



SUPERSOFT™ Patient Exam Cape

Extra large disposable exam vest features telemetry breast pockets, three sturdy snaps for improved privacy and vents on each side for stress cable exit. Disposable vest is made of non-woven SMS material.

Features

1. Soft, opaque, nonwoven material ensures patient privacy
2. Latex-free waistband provides optimal fit and comfort
3. Ideal for lower body plastic surgery exams
4. Liposuction, Leg Laser Treatments, Bikini Waxing, Tummy Tucks, Before and After Photos





CROSSGARD™

PROTECTION

CROSSGARD™
4000

Product Info

CROSSGARD™ 4000 Coverall

Protective coverall in breathable microporous laminated nonwoven fabric, with sealed seam.

- ▶ Seams entirely sealed with blue tape
- ▶ Hood with elastic border
- ▶ Knitted cuffs or elastic cuffs are optional
- ▶ Elastic band at ankle
- ▶ Wide armhole for a maximum wearability and comfort during usage
- ▶ Silicon-free
- ▶ No particle release
- ▶ White color



50PCS/CARTON SIZES: M/L/XL/XXL/XXXL

CE  Cat. III^a



EN 13034 -Type 6
EN 13982-1 -Type 5
EN 14605 -Type 4



EN 1149



EN 1073-2



EN 14126



Back elastic band at waist, for a major body adherence

Adhesive strip zip cover, to grant an high level of waterproofness.

APPLICATION





Selecting the appropriate protective garment not only against to prevent injury, but may also help to prevent long-term occupational diseases. Your employees may put their health at risk. Therefore, they require protection that can be rely on and trusted.



Product Info

CROSSGARD™ 2000 Coverall

Protective coverall in Multiply SMMS nonwoven fabric.

- ▶ Bound stitched seam keep the performance of liquid resistance
- ▶ Hood with elastic border
- ▶ Knitted cuffs or elastic cuffs are optional
- ▶ Elastic band at ankle
- ▶ Wide armhole for a maximum wearability and comfort during usage
- ▶ Silicon-free
- ▶ No particle release
- ▶ White color



50PCS/CARTON SIZES: M/L/XL/XXL/XXXL

CE Cat. III^a

EN 13034 -Type 6
 EN 13982-1 -Type 5 EN 1149 EN 1073-2 EN 14126



Back elastic band at waist, For a major body adherence



Adhesive strip zip cover to grant an high level of waterproofness

APPLICATION





We offers an extensive surgical drape line.

Our standard drape collection features a top-of-the-line SMS fabric, composed of five strong fiber layers for exceptionally high barrier strength.

Made of 100% polypropylene, SMS drapes are soft and drapeable.

Composed with the latest generation SMS technology,

the SMS drapes have smaller fibers and a more uniform fiber lay-down.



Flat Drape

Code No.	GCB-011
Size	6*60cm

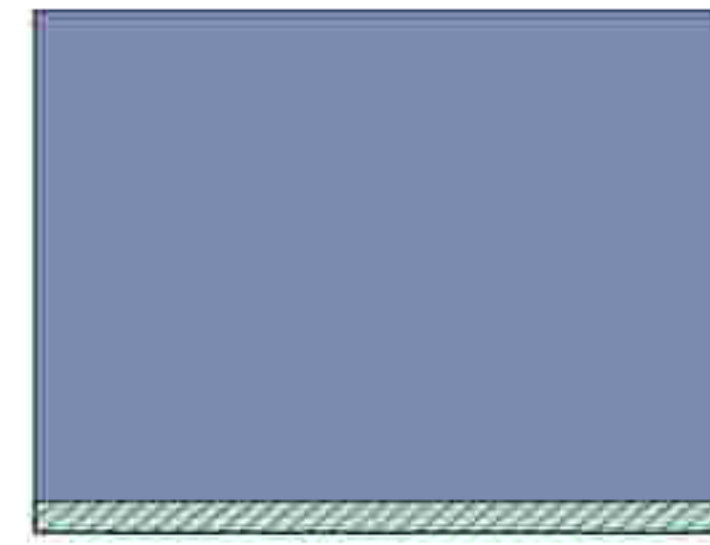

Flat Drape

Code No.	GCB-012
Size	100*100cm with adhesive 5*100cm

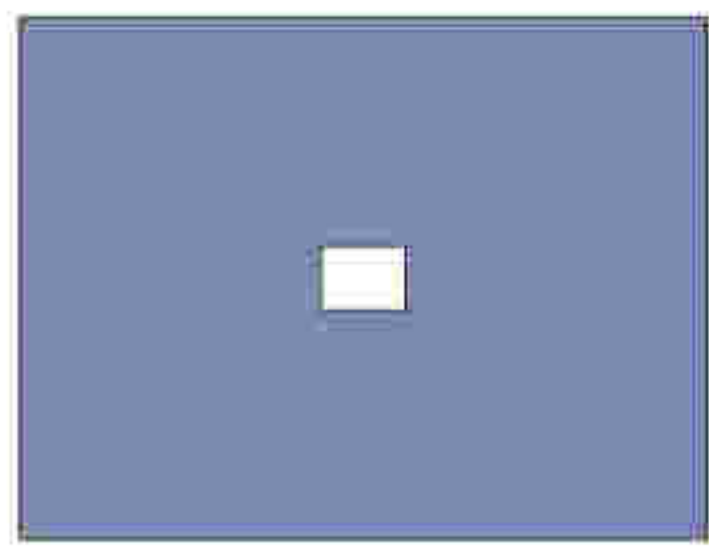

Fenestrated Drape

Code No.	GCB-013
Size	60*60cm
Fenestration	10*10cm

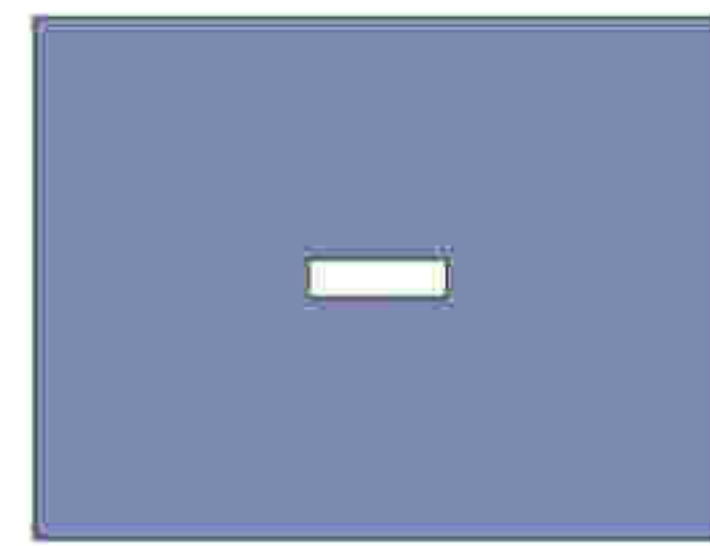

Fenestrated Drape

Code No.	GCB-014
Size	80*80cm
Fenestration	17*6cm

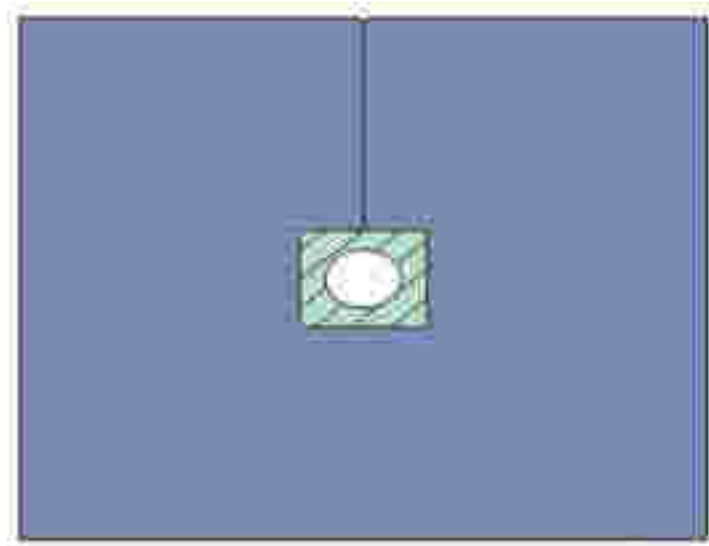

Procedure Drape

Code No.	GCB-015
Size	90*120cm
Fenestration	round \varnothing 6.5cm
Feature	15*15cm d/s tape around fenestration perforated from edge to centre

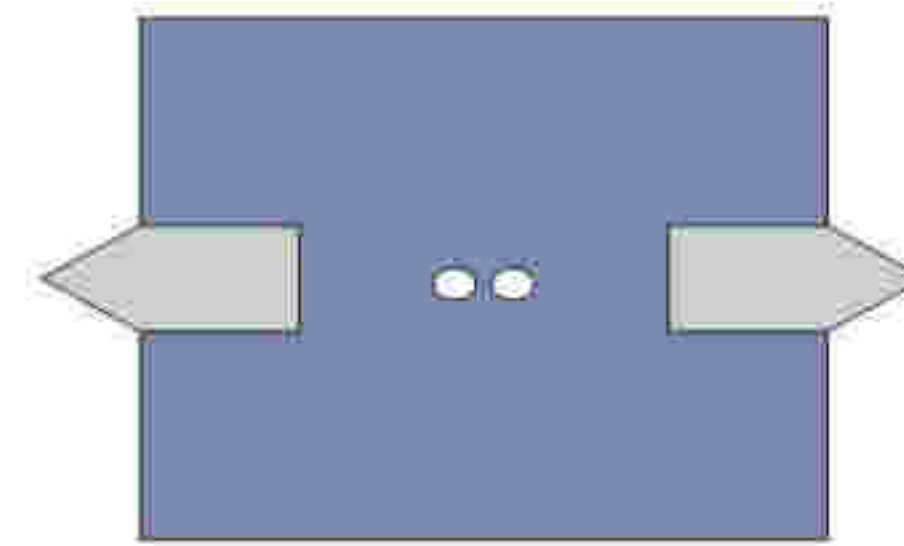

Ophthalmic Drape

Code No.	GCB-016
Size	60*60cm
Fenestration	two \varnothing 5cm with 10-10cm Incise
Feature	Fluid pouch and support wire

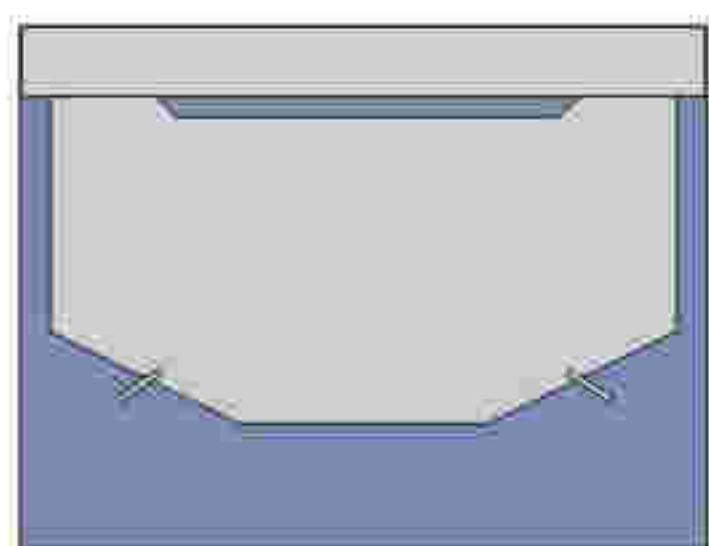

Head Drape

Code No.	GCB-017
Size	109*85cm

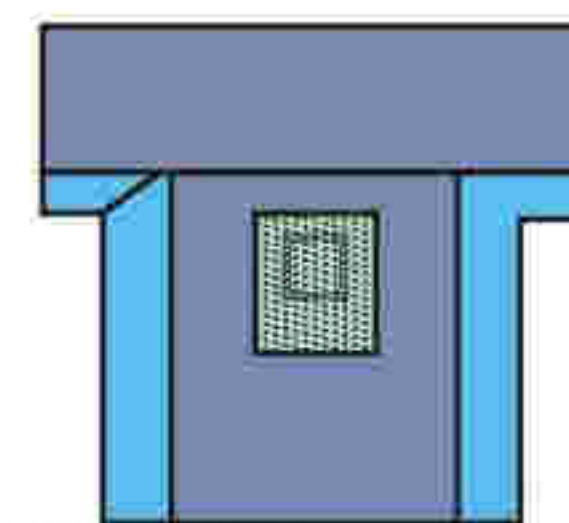

Laparotomy Drape

Code No.	GCB-018
Size	260*312cm
Rminforcement	60*85cm
Feature	10*30.5cm fenestration with 18.6*37 Incise, d/s tape, side view panels

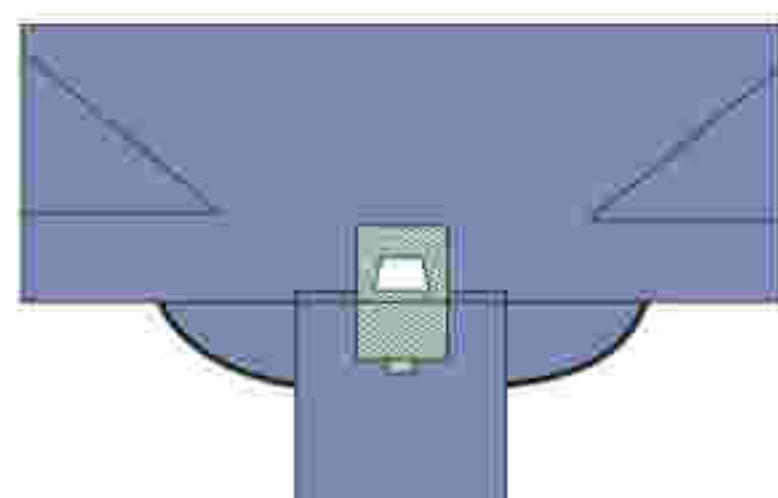

Laparotomy Drape

Code No.	GCB-019
Size	325*260cm
Rminforcement	40*75cm
Feature	Ladder-shaped fenestration

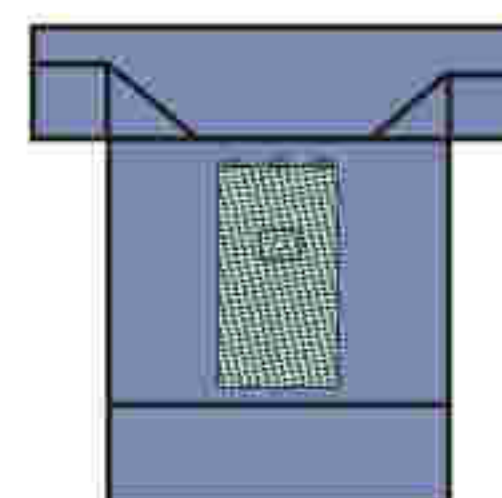

Extremity Drape

Code No.	GCB-020
Size	310*335cm
Rminforcement	760*165cm
Feature	6.5cm expandable fenestration,tube holders

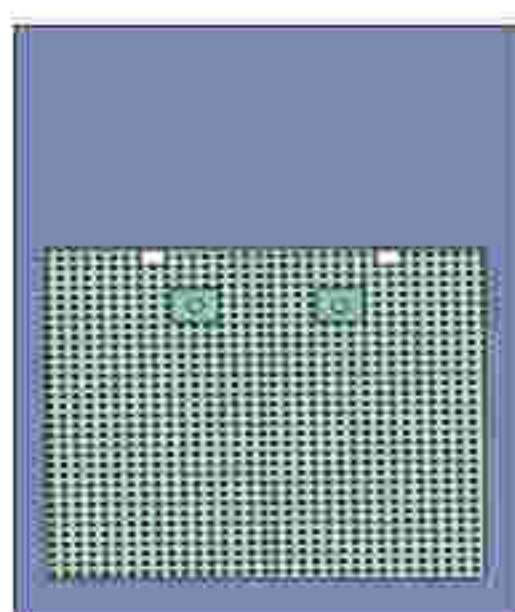

Extremity Drape

Code No.	GCB-021
Size	210*325cm
Fenestration	180*180cm
Feature	6.5cm expandable fenestration,tube holders

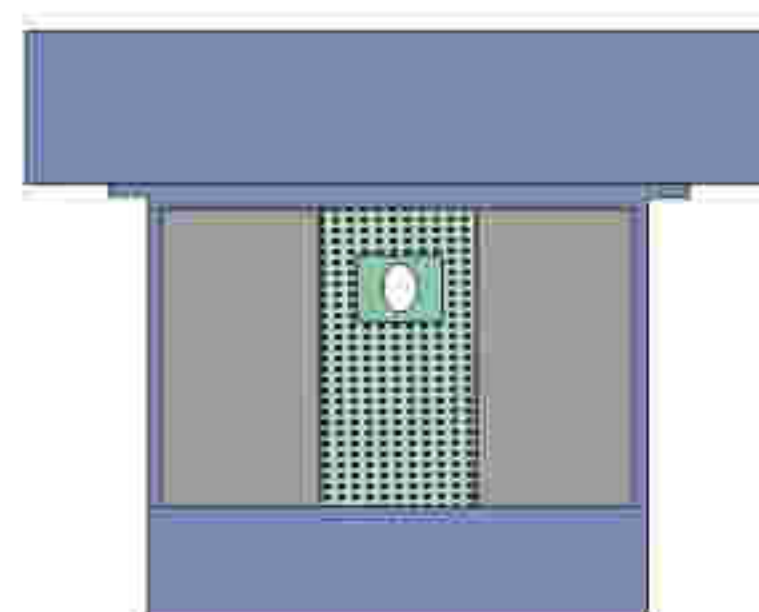

Hip Drape

Code No.	GCB-022
Size	310*320cm
Fenestration	52*160cm
Feature	expandable fenestrations,fluid pouch and support wire,tube holders

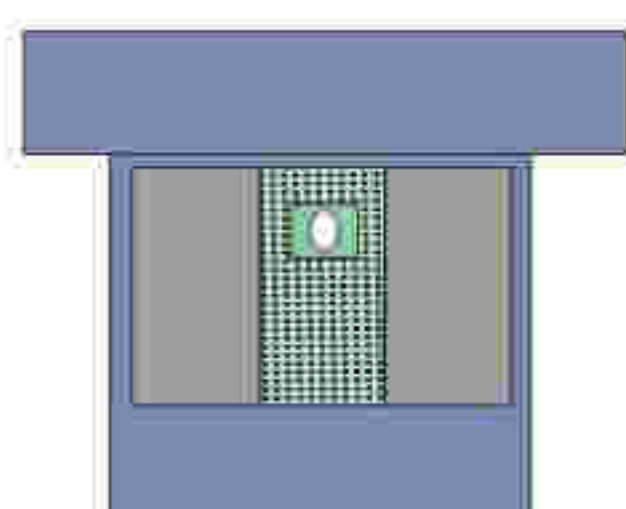

Hip Drape

Code No.	GCB-023
Size	292*351cm
Reinforcement	52*140cm
Feature	expandable fenestrations, fluid pouch and support wire

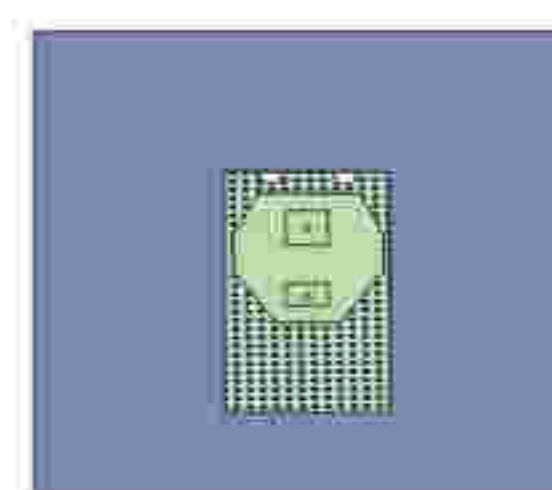

Arthroscopy Drape

Code No.	GCB-024
Size	300*350cm
Rminforcement	90*180cm
Feature	5*7.5cm oval expandable fenestration, fluid pouch

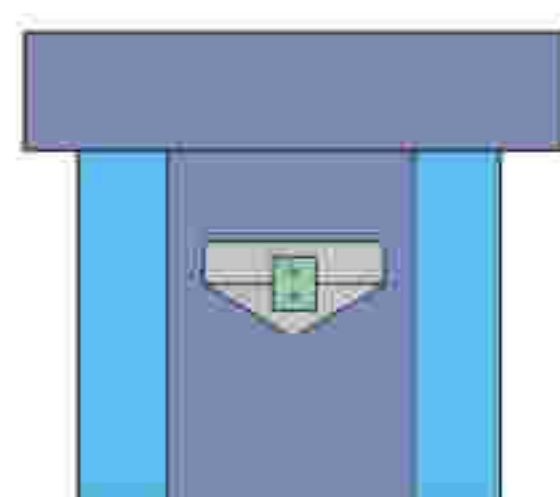

Arthroscopy Drape

Code No.	GCB-025
Size	447*295cm
Rminforcement	50*55cm
Feature	6cm and 5cm expandable fenestrations fluid pouch and support wire, side view panels

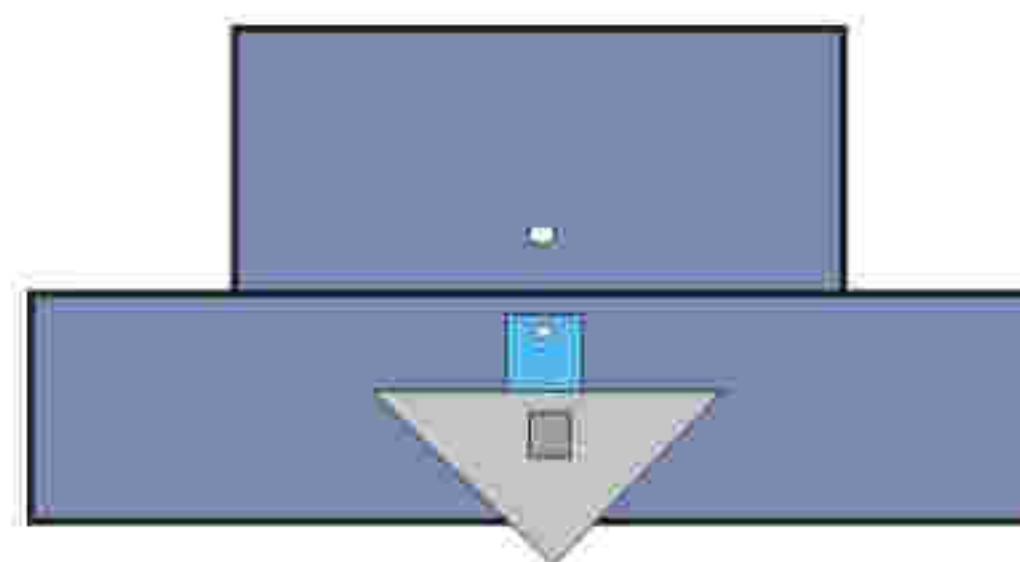

Tur Drape

Code No.	GCB-026
Size	258*165cm
Rminforcement	165cm
Feature	finger cor, pouch with mesh and drain port

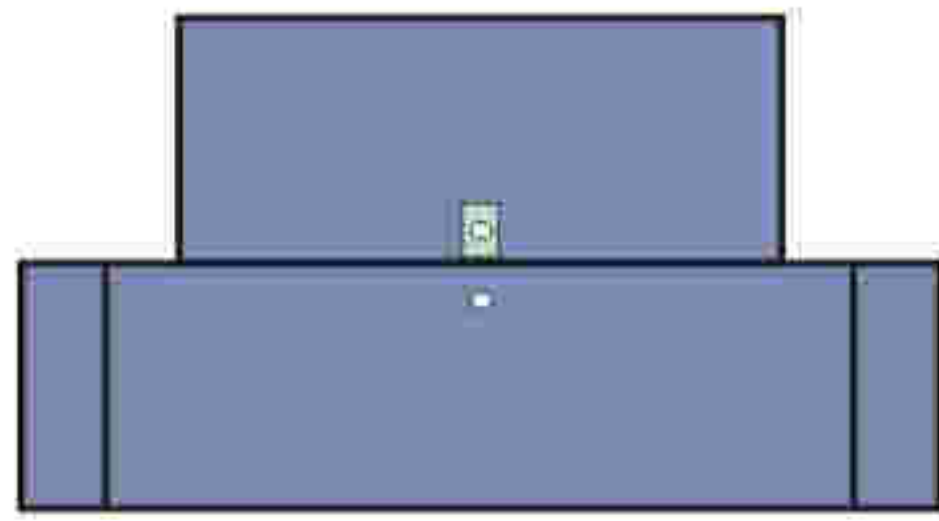

Tur Drape

Code No.	GCB-027
Size	266*186cm
Fenestration	6cm
Feature	finger cot, pouch with mesh and drain port

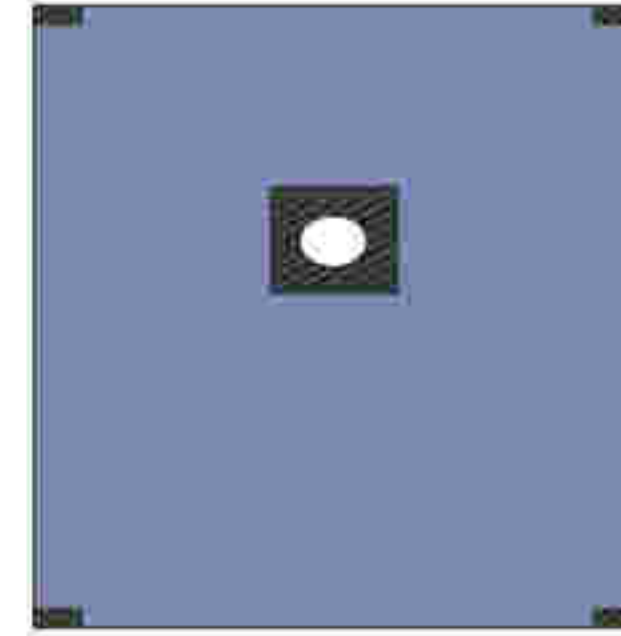

Brachial Drape

Code No.	GCB-028
Size	75*100cm
Feature	7.5*9.5cm oval fenestration with adhesive, d/s tape in corners

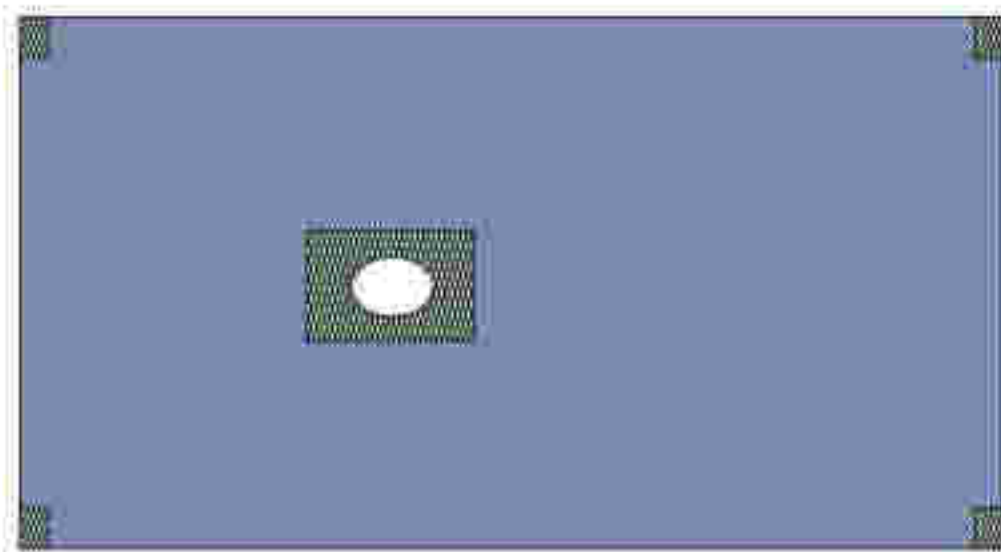

Brachial Drape

Code No.	GCB-029
Size	100*75cm
Feature	7.5*9cm oval fenestration, d/s tape

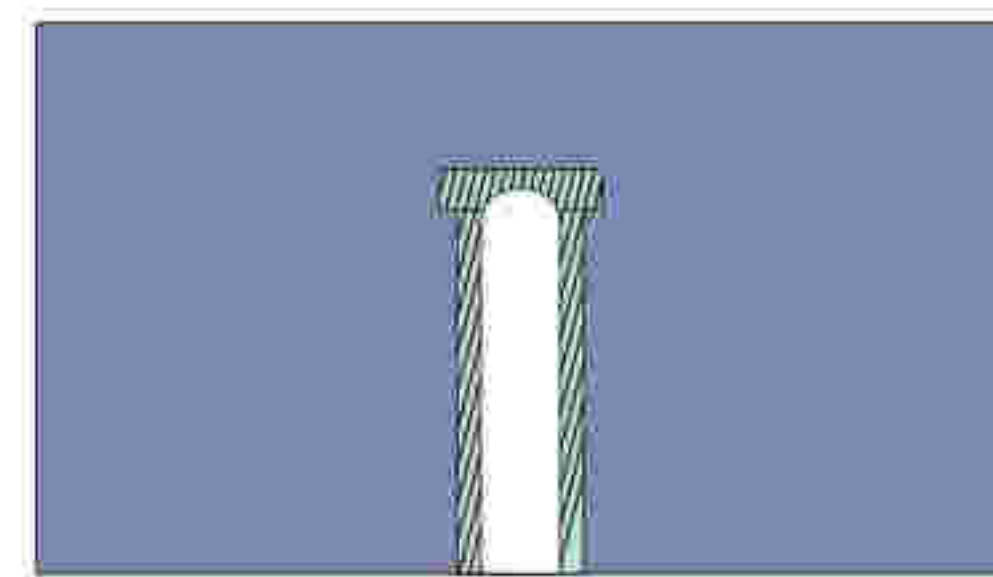

Split U Drape

Code No.	GCB-030
Size	150*200cm
Feature	arch15*93cm, d/s tape

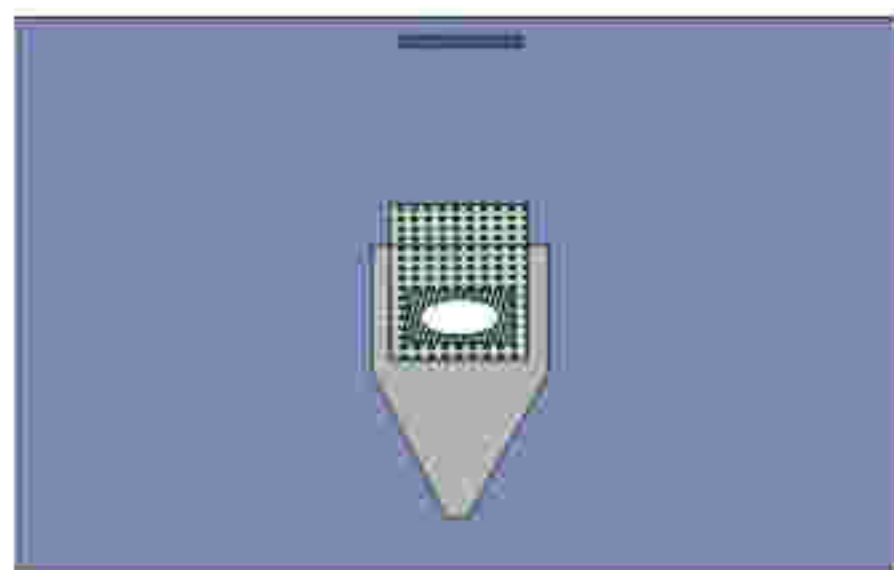

Craniotomy Drape

Code No.	GCB-031
Size	245*256cm
Rminforcement	48*74cm
Feature	18*28cm oval fenestration with incise, fluid pouch

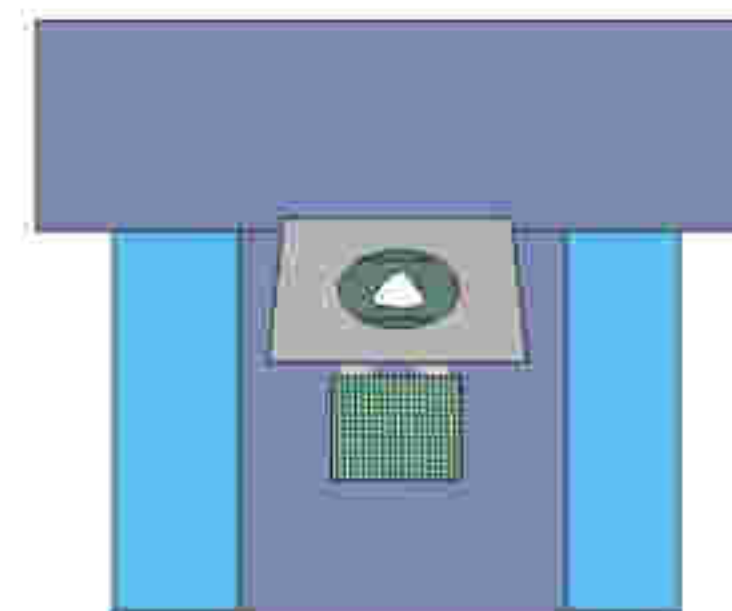

Caesarean Drape

Code No.	GCB-032
Size	249*312cm
Rminforcement	45*55cm
Feature	Oval fenestration with incise, fluid pouch with support wire, tube holders

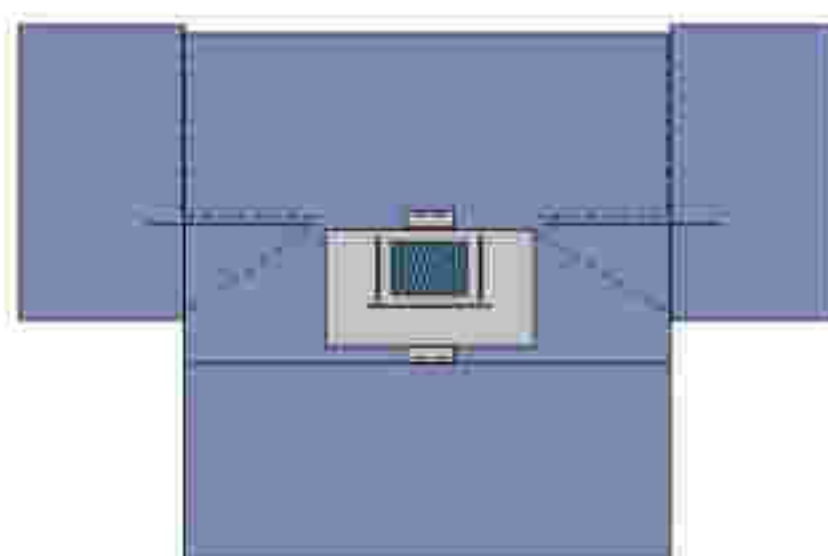

Caesarean Drape

Code No.	GCB-033
Size	343*310cm
Feature	fluid pouch with support wire and drain port, incise 38*38cm, tube holders

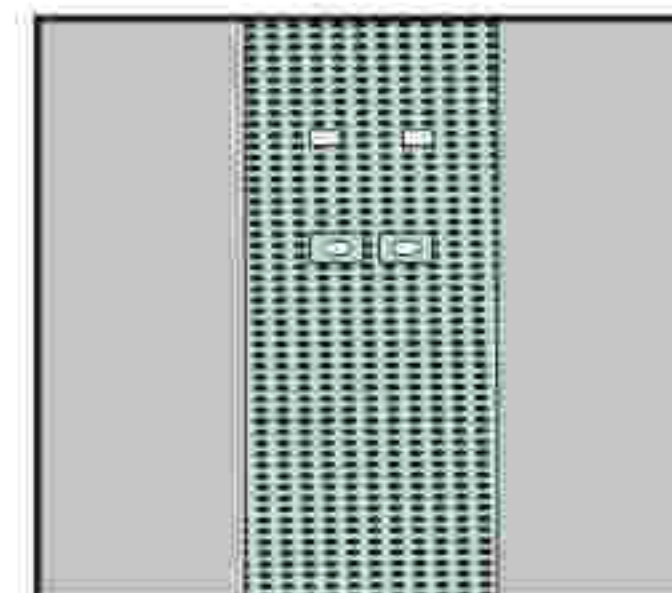

Angiography Drape

Code No.	GCB-034
Size	210*370cm
Reinforcement	82.5*370cm
Feature	two fenestrations square 10*10cm, two 6.5cm with incise, side view panels

BOUFFANT CAP

Polypropylene 10-16GSM

White/Blue/Green/Pink/Red Color

Size: 18-24"



1000PCS/CARTON

CE  Cat. I^a



APPLICATION



PEAKED CAP

Polypropylene 10-16GSM

White/Blue/Green/Pink/Red Color

Peak Paper Size: 18-24"



1000PCS/CARTON

CE  Cat. I^a



APPLICATION



SNOOD CAP

Side 60GSM + Peak 90GSM

White/Blue/Green/Pink/Red Color

Size: Universal



1000PCS/CARTON

CE  Cat. I^a



APPLICATION



NYLON HAIR NET

Nylon 18GSM

White/Black Color

Size: 18-24"



1000PCS/CARTON

CE  Cat. I^a



APPLICATION



HAIR BAND

Polypropylene With 4 elastics

White color

Size: L/XL



1000PCS/CARTON

CE  Cat. I^a



APPLICATION



MOB CAP

Polypropylene, single or double elastics

Detective strip is optional

White/Blue/Green/Pink/Red/Black Color

Size: 18-24"



1000PCS/CARTON

CE  Cat. I^a



APPLICATION



BEARD COVER

Polypropylene 10-16GSM

White/Blue/Green/Pink/Red Color

Size: L/XL



1000PCS/CARTON



Cat. I^a



APPLICATION



SURGICAL COVER

SMS 30-55GSM

White/Blue/Green Color

Size: Universal



1000PCS/CARTON

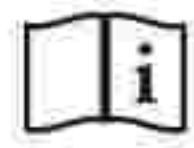

Cat. I^a



APPLICATION



NYLON HOOD

Nylon 18G

White color

Size: Universal



1000PCS/CARTON



Cat. I^a



APPLICATION



SMS Surgical Cap

1. Soft and absorbent SMS material, ventilated crown and adjustable ties or elastic band
2. Comfortable and Breathable
3. Latex-free



500PCS/CARTON



Cat. I^a



APPLICATION



Scrim Reinforced Surgical Cap Kaycel-like

- SRM - Scrim reinforced material, a paper-like absorbent material
- Multi-Layer Polypropylene - Highly fluid-resistant, yet breathable
- Spunlace- Extremely soft, comfortable and most absorbent



500PCS/CARTON

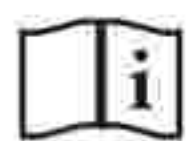

Cat. I^a



APPLICATION



SHOE COVER

CROSSGARD™

Microporous Laminated fabric

Elastic ankle SIZES: UNIVERSAL



500PCS/CARTON



Cat. I^a



APPLICATION



SHOE COVER

HEAVY DUTY CPE

Ultrasonic heat seam

Elastic ankle SIZES: UNIVERSAL



500PCS/CARTON



Cat. I^a



APPLICATION



SHOE COVER

ANKLE HIGH

Ultrasonic heat seam

Elastic ankle SIZES: UNIVERSAL



500PCS/CARTON



Cat. I^a



APPLICATION



SHOE COVER

CPE/PE

CPE/PE 2.0-4.0 gr

Elastic ankle light blue color

Size: 15x36cm, 15x41cm



2000PCS/CARTON

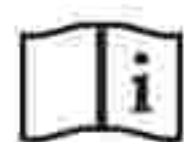

Cat. I^a



APPLICATION



SHOE COVER

CPE COATED PP

Weight 10gr

Elastic ankle light blue color

Size: UNIVERSAL



1000PCS/CARTON



Cat. I^a



APPLICATION



SHOE COVER

PVC SOLE

Ultrasonic heat seam

Elastic ankle light blue color

Size: UNIVERSAL



500PCS/CARTON



Cat. I^a



APPLICATION



BOOT COVER

MEDIUM WEIGHT CPE

Elastic ankle
SIZES: UNIVERSAL

 500PCS/CARTON

  Cat. I^a



APPLICATION



BOOT COVER

HEAVY DUTY CPE

Elastic ankle White color
SIZES: UNIVERSAL

 500PCS/CARTON

  Cat. I^a



APPLICATION



BOOT COVER

CROSSGARD™

Microporous Laminated fabric 65gr
Elastic ankle SIZES: UNIVERSAL

 500PCS/CARTON

  Cat. I^a



APPLICATION



BOOT COVER

MULTIPLY SMS

Elastic ankle
Size: L/XL

 500PCS/CARTON

  Cat. I^a



APPLICATION



BOOT COVER

MULTIPLY SMS

Anti-skid sole
Elastic ankle light blue color
Size: L/XL

 500PCS/CARTON

  Cat. I^a



APPLICATION



BOOT COVER

WITH PVC SOLE

Elastic ankle
Two elastic bands on leg
Size: L/XL

 500PCS/CARTON

  Cat. I^a



APPLICATION



WHY GREENCROSS™ MASK ?

510K Number:K123787

Enhanced Safety and Performance!

GREENCROSS offers a wide variety of mask designs, fit and filtration to match the protection needs for each procedure or risk level. The GREENCROSS Mask filtration guide makes it easy to select the level of filtration required, including ASTM Level 1, 2 and 3 and N95 particulate respiration. From minimum performance masks for dry, short procedures, to our maximum filtration mask, Isolator Plus, GREENCROSS has the right mask for the task!



<p>MAXIMUM FILTRATION</p> <p>Indicated for use when treating patients with airborne diseases such as TB or influenza.</p> <p>Meets CE 0121-In reference to EN 149: 2001 FFP2 NR</p>			<p>N95 Particulate Respirator</p> <ul style="list-style-type: none"> • NIOSH approved N95 Respirator. • Meets guidelines for TB exposure control • Resistance to penetration by synthetic blood: 160mmHg.
<p>ASTM LEVEL 3</p> <p>Ideal for procedures where heavy to moderate amounts of fluid, spray and/or aerosols are produced.</p> <p>Meets EN14683 Rating-Type IIR Standard.</p>			<p>Ultra Sensitive Earloop Technology</p> <ul style="list-style-type: none"> • BFE = 99.9% @ 3 microns. • PFE = 99.9% @ 0.1 micron. • Patent pending design with aluminum strip under chin for custom fit. • Fluid resistant outer layer. • White hypoallergenic inner cellulose layer. • Extra soft – will not link, tear or shred. • Free of chemicals, inks and dyes. • Extra-long aluminum nose piece.
<p>ASTM LEVEL 2</p> <p>Ideal for procedures where moderate to light amounts of fluid, spray and/or aerosols are produced.</p> <p>Meets EN14683 Rating-Type IIR Standard.</p>			<p>Procedural Surgical Mask</p> <ul style="list-style-type: none"> • BFE = 99.9% @ 3 microns. • PFE = 99.7% @ 0.1 micron. • Patent pending design with aluminum strip under chin for custom fit. • Fluid resistant outer layer. • Fluid resistant white inner layer. • Extra-long aluminum nose piece.
<p>ASTM LEVEL 1</p> <p>Ideal for procedures where low amounts of fluid, spray and/or aerosols are produced.</p> <p>Meets EN14683 Rating-Type II Standard.</p>			<p>Isolation Face Mask</p> <ul style="list-style-type: none"> • BFE = 98.4% @ 3 microns. • PFE = 98.5% @ 0.1 micron. • Patent pending design with aluminum strip under chin for custom fit. • Fluid resistant outer layer. • White tissue inner layer. • Extra-long aluminum nose piece.
<p>LOW PERFORMANCE</p> <p>Ideal as a comfortable substitute for earloop face masks, this mask is a simple physical barrier ideal for exams and visitations or for dry, short procedures that do not produce fluid, spray or aerosols.</p>			<p>Universal Face Mask</p> <ul style="list-style-type: none"> • BFE = 95% @ 3 microns. • PFE = 95% @ 0.1 micron. • Patent pending design with aluminum strip under chin for custom fit. • Fluid resistant outer layer. • White tissue inner layer. • Extra-long aluminum nose piece.
<p>MINIMUM PERFORMANCE</p> <p>Ideal as a simple physical barrier for exams, isolation and visitations or for dry, short procedures that do not produce fluid, spray or aerosols.</p>			<p>Molded Mask</p> <ul style="list-style-type: none"> • PFE = 98.7% @ 4.2 microns. • Splash resistant barrier. • Flared edge prevents irritation. • Soft, flexible nose piece.
<p>Comfortable 3D Performance</p> <p>Ideal as a comfortable substitute for earloop face masks, this mask is a simple physical barrier ideal for exams and visitations or for dry, short procedures that do not produce fluid, spray or aerosols.</p>			<p>3D Mask</p> <ul style="list-style-type: none"> • BFE = 98.4% @ 3 microns. • PFE = 98.5% @ 0.1 micron. • Patent pending design with aluminum strip under chin for custom fit. • Fluid resistant outer layer. • White tissue inner layer. • Extra-long aluminum nose piece.

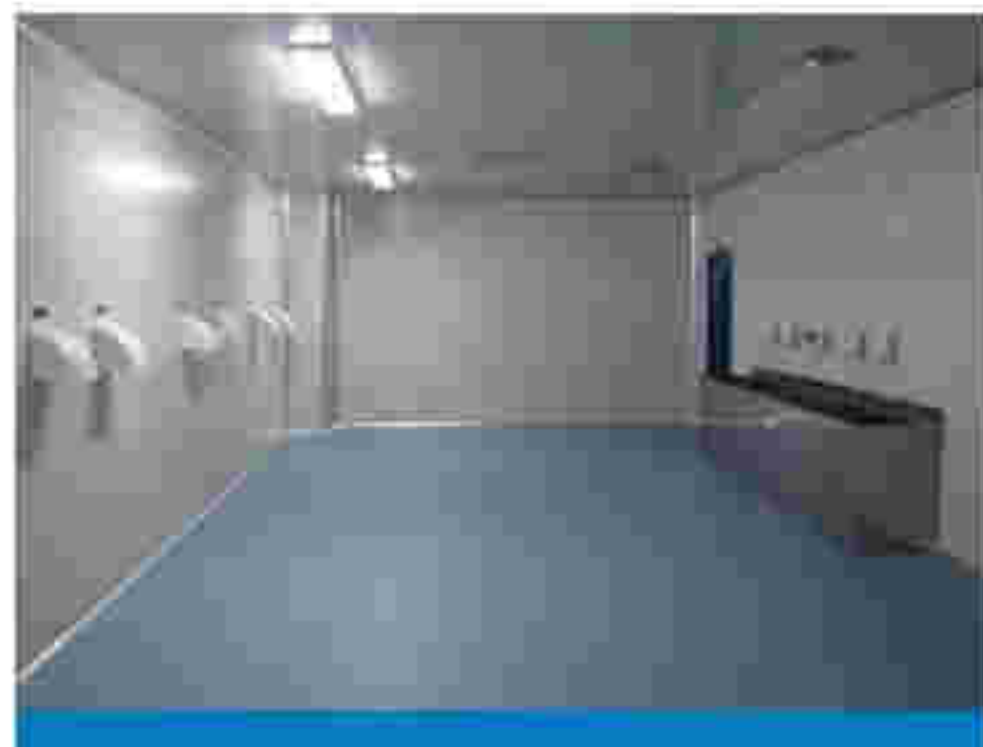
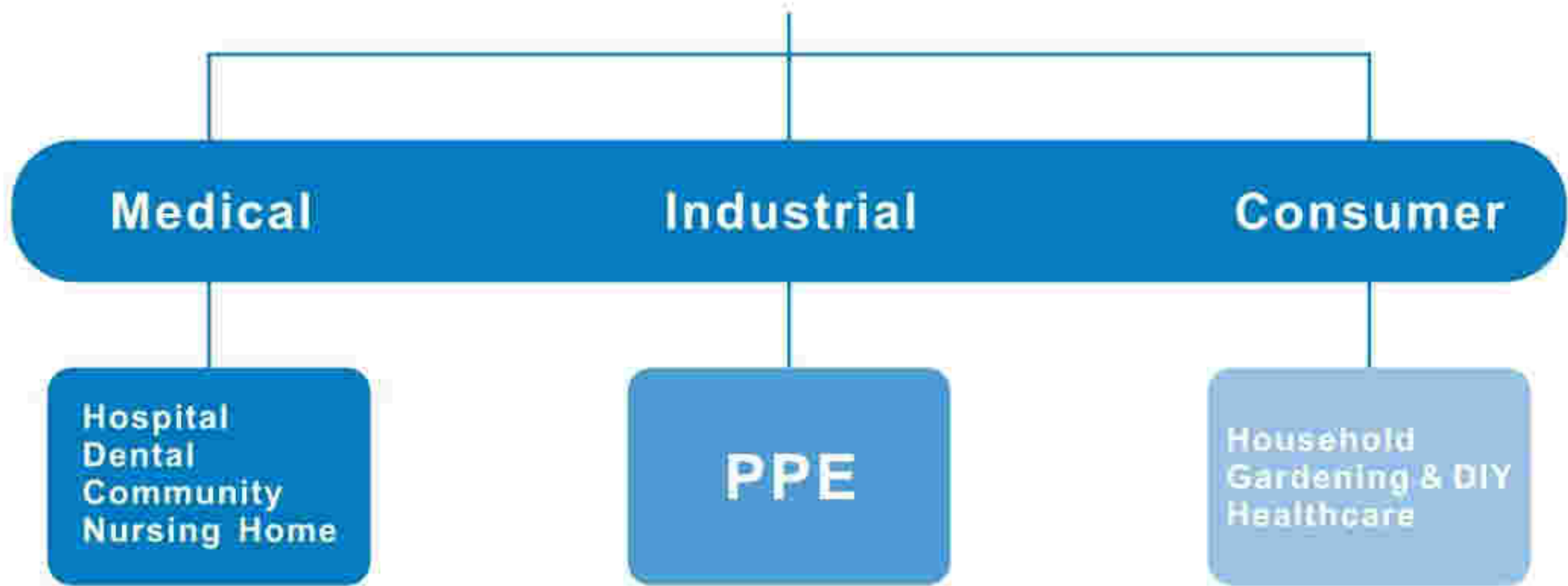

AGS-Medical, Ph: (505) 550-6501 & (505) 565-5102, Fx: (505) 814-5778
Email: sales@agsmedical.com, Web: www.agsmedical.com